



The HOBO U20L Water Level Logger is used for monitoring changing water levels in a wide range of applications, including streams, lakes, wetlands, tidal areas, and groundwater. Using HOBOware® Pro, you can easily configure this logger to record absolute pressure and temperature data. This logger features a ceramic pressure sensor, durable housing, and a protective end cap for deployment in existing wells or stilling wells. Without cumbersome vent tubes or desiccants to maintain, this easy-to-use logger is an ideal solution for water level studies and research.

## Specifications

### HOBO Water Level Logger

#### Models:

- U20L-01 (30-foot depth)
- U20L-02 (100-foot depth)
- U20L-04 (13-foot depth)

#### Required Items:

- Coupler (COUPLER2-C) with USB Optic Base Station (BASE-U-4) or HOBO Waterproof Shuttle (U-DTW-1, firmware version 3.2.0 or later)\*
- HOBOware® Pro, version 3.5 or higher

#### Accessories:

- Cable (CABLE-1-300 or CABLE-1-50) and Cable Crimp (CABLE-1-CRIMP)
- Replacement Coupler (COUPLER2-C)

*\*If shuttle firmware version 3.2.0 or later is needed, see the Onset website or contact Onset Technical Support.*

#### Pressure (Absolute) and Water Level Measurements U20L-01

<b>Operation Range</b>	0 to 207 kPa (0 to 30 psia); approximately 0 to 9 m (0 to 30 ft) of water depth at sea level, or 0 to 12 m (0 to 40 ft) of water at 3,000 m (10,000 ft) of altitude
<b>Factory Calibrated Range</b>	69 to 207 kPa (10 to 30 psia), 0° to 40°C (32° to 104°F)
<b>Burst Pressure</b>	310 kPa (45 psia) or 18 m (60 ft) depth
<b>Water Level Accuracy*</b>	Typical error: ±0.1% FS, 1.0 cm (0.03 ft) water Maximum error: ±0.2% FS, 2.0 cm (0.06 ft) water
<b>Raw Pressure Accuracy**</b>	±0.3% FS, 0.62 kPa (0.09 psi) maximum error
<b>Resolution</b>	<0.02 kPa (0.003 psi), 0.21 cm (0.007 ft) water
<b>Pressure Response Time (90%***)</b>	<1 second at a stable temperature; measurement accuracy also depends on temperature response time

#### Pressure (Absolute) and Water Level Measurements U20L-02

<b>Operation Range</b>	0 to 400 kPa (0 to 58 psia); approximately 0 to 30.6 m (0 to 100 ft) of water depth at sea level, or 0 to 33.6 m (0 to 111 ft) of water at 3,000 m (10,000 ft) of altitude
<b>Factory Calibrated Range</b>	69 to 400 kPa (10 to 58 psia), 0° to 40°C (32° to 104°F)
<b>Burst Pressure</b>	500 kPa (72.5 psia) or 40.8 m (134 ft) depth
<b>Water Level Accuracy*</b>	Typical error: ±0.1% FS, 3.0 cm (0.1 ft) water Maximum error: ±0.2% FS, 6.0 cm (0.2 ft) water
<b>Raw Pressure Accuracy**</b>	±0.3% FS, 1.20 kPa (0.17 psi) maximum error
<b>Resolution</b>	<0.04 kPa (0.006 psi), 0.41 cm (0.013 ft) water
<b>Pressure Response Time (90%***)</b>	<1 second at a stable temperature; measurement accuracy also depends on temperature response time

#### Pressure (Absolute) and Water Level Measurements U20L-04

<b>Operation Range</b>	0 to 145 kPa (0 to 21 psia); approximately 0 to 4 m (0 to 13 ft) of water depth at sea level, or 0 to 7 m (0 to 23 ft) of water at 3,000 m (10,000 ft) of altitude
<b>Factory Calibrated Range</b>	69 to 145 kPa (10 to 21 psia), 0° to 40°C (32° to 104°F)
<b>Burst Pressure</b>	310 kPa (45 psia) or 18 m (60 ft) depth
<b>Water Level Accuracy*</b>	Typical error: ±0.1% FS, 0.4 cm (0.013 ft) water Maximum error: ±0.2% FS, 0.8 cm (0.026 ft) water
<b>Raw Pressure Accuracy**</b>	±0.3% FS, 0.43 kPa (0.063 psi) maximum error
<b>Resolution</b>	<0.014 kPa (0.002 psi), 0.14 cm (0.005 ft) water
<b>Pressure Response Time (90%***)</b>	<1 second at a stable temperature; measurement accuracy also depends on temperature response time

Specifications (continued)

Temperature Measurements (All Models)

Operation Range	-20° to 50°C (-4° to 122°F)
Accuracy	±0.44°C from 0° to 50°C (±0.79°F from 32° to 122°F), see Plot A
Resolution	0.10°C at 25°C (0.18°F at 77°F), see Plot A
Response Time (90%)	10 minutes in water (typical)
Stability (Drift)	0.1°C (0.18°F) per year

Logger

Real-time Clock	±1 minute per month 0° to 50°C (32° to 122°F)
Battery	2/3 AA, 3.6 Volt lithium, factory-replaceable
Battery Life (Typical Use)	5 years with 1 minute or greater logging interval
Memory (Non-volatile)	64K bytes memory (approx. 21,700 pressure and temperature samples)
Weight	Approximately 154 g (5.43 oz) in air Approximately 53.9 g (1.9 oz) in fresh water
Dimensions	3.18 cm (1.25 inches) diameter, 15.24 cm (6.0 inches) length; mounting hole 6.3 mm (0.25 inches) diameter
Wetted Materials	Polypropylene housing and lanyard; Viton and Buna-N O-rings; ceramic sensor in acetal end cap; stainless steel screws suitable for saltwater
Logging Interval	Fixed-rate or multiple logging intervals, with up to 8 user- defined logging intervals and durations; logging intervals from 1 second to 18 hours. Refer to the <i>HOBOWare User's Guide</i> for details.
Launch Modes	Immediate start and delayed start
Offload Modes	Offload while logging; stop and offload
Battery Indication	Battery voltage can be viewed in status screen and optionally logged in datafile. Low battery indication in datafile.
Environmental Rating	IP68



The CE Marking identifies this product as complying with all relevant directives in the European Union (EU).

- \* Water Level Accuracy: With accurate reference water level measurement, known water density, accurate Barometric Compensation Assistant data, and a stable temperature environment.
- \*\* Raw Pressure Accuracy: Absolute pressure sensor accuracy includes all sensor drift, temperature, and hysteresis-induced errors.
- \*\*\* Changes in Temperature: Allow 20 minutes in water to achieve full temperature compensation of the pressure sensor. Maximum error due to rapid thermal changes is approximately 0.5%.

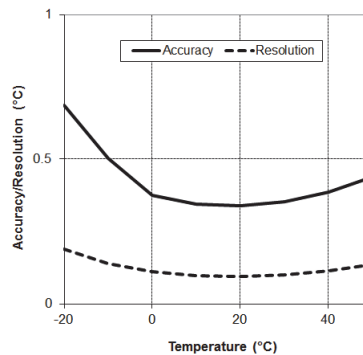

Plot A

## Logger Operation

HOBOWare Pro software is required for logger operation. Using a reference water level, HOBOWare Pro automatically converts pressure readings into water level readings (see *Barometric Compensation* for more detail). The software also supports compensation for temperature, fluid density, and barometric pressure.

An LED in the communications window of the logger confirms logger operation. When the logger is logging, the LED blinks once every one to four seconds (the shorter the logging interval, the faster the LED blinks). The LED also blinks when the logger is recording a sample. When the logger is awaiting a start because it was configured to start “At Interval,” “On Date/Time,” or “Using Coupler,” the LED blinks once every eight seconds until logging begins.

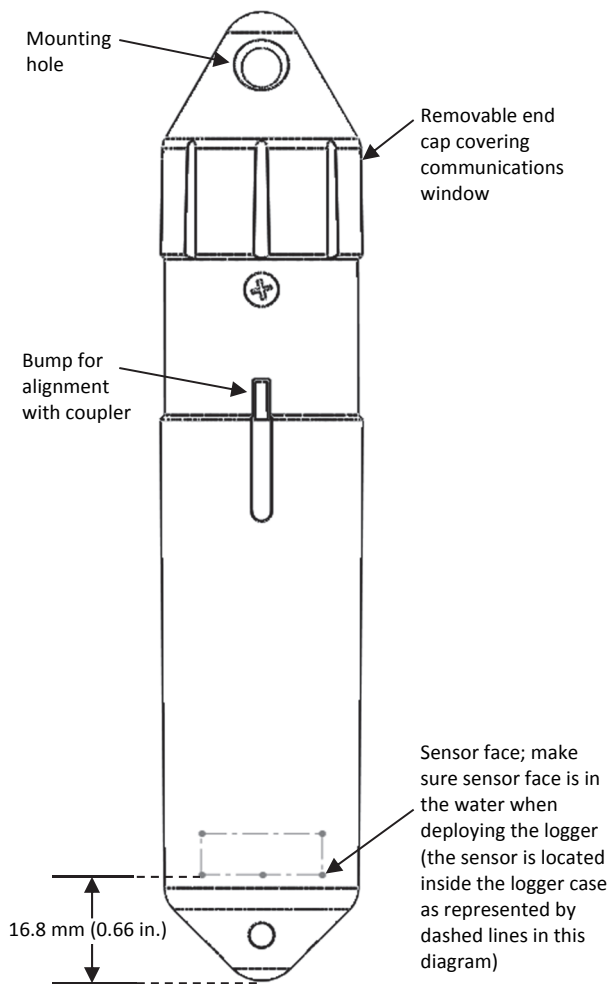

The logger can record two types of data: samples and events. Samples are the sensor measurements recorded at each logging interval (for example, the pressure every minute). Events are independent occurrences triggered by a logger activity, such as Bad Battery or Host Connected. Events help you determine what was happening while the logger was logging.

## Barometric Compensation

The logger records absolute pressure, which is later converted to water level readings by HOBOWare Pro software. In this application, absolute pressure includes atmospheric pressure and water head. Atmospheric pressure is nominally 100 kPa (14.5 psi) at sea level, but it changes with weather and altitude. Left uncompensated, barometric variations could result in errors of 0.6 m (2 ft) or more.

To compensate for barometric pressure changes, you can use another HOBO U20L Water Level logger as a barometric reference. The barometric reference is typically deployed in the same well or at the same location as the water level of interest, but rather than being placed in the water column, it is deployed above the water in air.

Barometric pressure readings are consistent across a region (except during fast-moving weather events), so you can generally use barometric pressure readings that are taken within 15 km (10 miles) of the logger or more without significantly degrading the accuracy of the compensation.

Therefore, one HOBO U20L or U20 Water Level logger or weather station (HOBO U30 recommended) can be used to compensate all the water level loggers in an area. The U20L-01 model with its 0–9m (0–30 ft) range or the U20L-04 with its 0–4 m (0–13 ft) range are both good barometric references due to their smaller range and temperature-compensated accuracy. HOBOWare Pro includes a Barometric Compensation Assistant for easy and accurate barometric compensation. See *Processing Water Level Data using Barometric Pressure Data* for more details.

## Calibration

The pressure sensor in each HOBO U20L Water Level logger is individually calibrated. During calibration, raw pressure sensor data is collected at multiple pressures and temperatures over the calibrated range of the logger (see the specifications table). This data is used to generate calibration coefficients that are stored in the logger’s non-volatile memory. The calibration coefficients are then checked to be sure that the logger meets its stated accuracy over the calibrated range.

The pressure sensor can be used at pressures and temperatures that are outside of the calibrated range, but the accuracy cannot be guaranteed.

**Important: Never exceed the burst pressure of the sensor!**

## Connecting the Logger to a Computer

The HOBO Water Level Logger requires a coupler (COUPLER2-C) and Optic Base Station (BASE-U-4) or HOBO Waterproof Shuttle (U-DTW-1, firmware version 3.2.0 or later) to connect to the computer. The optical interface allows the logger to be offloaded without breaking the integrity of the seals. The USB compatibility allows for easy setup and fast downloads.

**Important: USB communications may not function properly at temperatures below 0°C (32°F) or above 50°C (122°F).**

1. Follow the instructions that came with your base station or shuttle to attach it to a USB port on the computer.
2. Unscrew the black plastic end cap from the logger by turning it counter-clockwise. **Note:** If the logger has been deployed, there may be water in the end cap. This is normal; this water will not penetrate the waterproof seal around the communications window in the logger.
3. Attach the coupler to the base station or shuttle.
4. Insert the logger into the coupler so that the alignment bump on the logger slides into the alignment bump on the coupler. Be sure it is properly seated in the coupler. It may take a few seconds for the new hardware to be detected by the computer.

**NOTE:** If you are using the Waterproof Shuttle, briefly press the coupler lever to put the shuttle into base station mode.

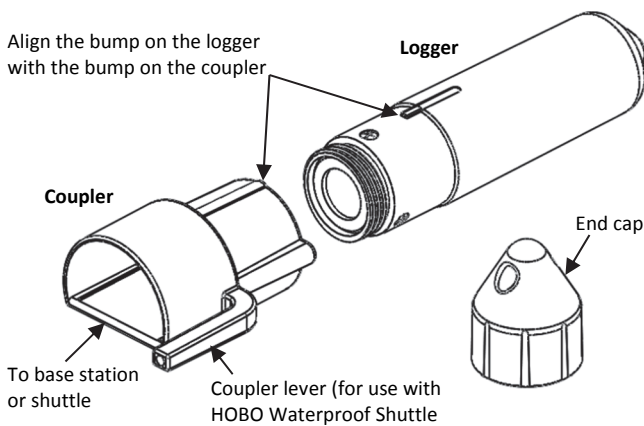

If the logger has never been connected to the computer before, it may take a few seconds for the new hardware to be detected by the computer.

**WARNING:** Do not leave the logger in the coupler for extended periods of time. When connected to a coupler, the logger is “awake” and consumes significantly more power than when it is disconnected and considered “asleep.” Always remove the logger from the Optic Base Station or HOBO Waterproof Shuttle as soon as possible after launching, reading out, or checking the status to avoid draining the battery. To “wake up” the logger, remove it from the coupler, wait a moment and then re-insert the logger.

## Launching the Logger

Before deploying the HOBO U20 Water Level Logger in the field, perform the following steps in the office:

1. Open HOBOWare.
2. Connect the logger to the computer as described in the previous section.
3. From the Device menu, select Launch.
4. In the Launch Logger window, make sure both the Abs. Pressure and Temperature sensors are selected (temperature is required for temperature compensation of pressure).

5. Select any other launch settings as desired, including when to start logging and the logging interval. Click the Start button in the lower right corner of the Launch Logger window to send the launch settings to the logger (note that the Start button text changes based on the Start Logging selection).

## Deploying the Logger

The HOBO Water Level Logger is designed to be easy to deploy in many environments. The logger uses an absolute pressure sensor, so no vent tube is required. The small size of the logger is convenient for use in small wells and allows the logger to be mounted and/or hidden in the field. Follow these guidelines when deploying the logger:

- The pressure sensor is temperature compensated over the range of 0° to 40°C (32° to 104°F). To obtain the highest level of accuracy, the logger should be allowed to come to full temperature equilibrium (approximately 20 minutes) before the reference level is recorded.
  - Sudden temperature changes should be avoided. When deploying a HOBO U20L Water Level Logger for barometric pressure reference, some consideration should be made to minimize the rate of temperature fluctuations. Ideally, the barometric pressure reference logger should be hung several feet below ground level in an observation well where ground temperatures are stable (while making sure the logger remains above the water level). If that is not possible (or if a well is not used), try to put the logger in a location where it will not be subject to rapid daily temperature cycles.
  - When deploying a HOBO Water Level logger in a well, make sure the well is vented to the atmosphere. Typically, a small hole can be drilled in the well cap to ensure that the pressure inside and outside the well is at equilibrium. If this is not possible, the barometric pressure reference logger should be used inside the same well.
  - Use a no-stretch wire to hang the water level logger. Any change in length of the wire will result in a 1-to-1 corresponding error in the depth measurement. Always pull-test a cable prior to deploying a logger in a well to make sure it does not stretch.
  - If you are deploying the logger in a lake, river, or stream, you must first build a stilling well to protect the logger from vibration, shock, and movement. A simple stilling well can be constructed with PVC or ABS pipe. A properly constructed stilling well helps to protect the logger from currents, wave action, and debris. Suspend the logger in the stilling well so it is always underwater, but not on the bottom to be buried by silt.
- For more information, see the Technical Application Note for Constructing a Stilling Well at:  
[http://www.onsetcomp.com/water\\_level\\_stilling\\_well.html](http://www.onsetcomp.com/water_level_stilling_well.html)
- To prevent the logger from moving in currents and to ensure the support cable is kept straight during deployment, you may need to add a weight to the suspension cable or hang a weight below the logger.

Alternatively, you could deploy the logger in a stilling well as described above.

- Be very careful not to exceed the burst pressure for the logger. The pressure sensor will burst if the maximum depth is exceeded (see specifications table). The logger should be positioned at a depth where the logger will remain in the water for the duration of the deployment, but not exceed the rated bursting depth.

To deploy the logger:

1. Cut wire to suspend logger.
  - a. Measure the physical depth to the surface of the water from the suspension point.
  - b. Cut a piece of stranded, stainless steel wire (Teflon coated is best) so that the logger will be deep enough to always be in the water. Estimate the low water level and make the cable length such that the logger will be about 2 feet below that level.
2. Attach the wire to the suspension point and to the logger cap.
3. Relaunch the logger if desired (if a laptop or a HOBO U-Shuttle is available).
4. Lower the logger into the well or stilling well.

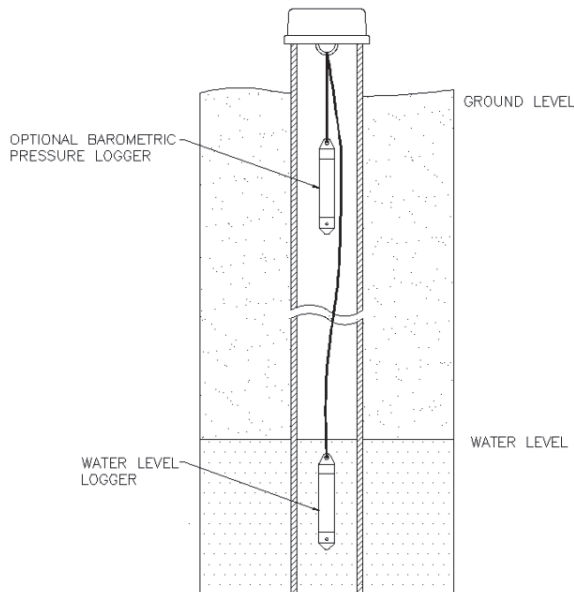

5. Measure the water depth from the desired reference point (top of pipe, ground level, or sea level).
  - To maximize accuracy, allow 20 minutes after deploying the logger before measuring water depth to allow the logger to reach temperature equilibrium with the water.
  - If the well is too small in diameter to measure the water depth after deployment, measure the water depth before deployment, then deploy the logger immediately and record deployment time.
  - For well deployments: If the water level surface is below the reference point (such as referencing groundwater measurements to the top of the well), record the water level as a negative number. If the water level surface is

above the reference point (such as height above sea level), record the water level as a positive number.

- For lake, stream, and river deployments: If the water level is being referenced to some point above the logger (such as the top of the stilling well), record the water level as a negative number. If the water depth is being referenced to a point below the water surface such as the bottom of the stream, record the water level as a positive number.

6. Record the reference measurement date and time.

### Deploying a Water Level Logger for Barometric Pressure Data (Optional)

If you are using a U20 or U20L logger to record barometric pressure data, install one logger in one of the wells as follows:

1. Cut wire for suspending the logger.
  - a. Measure the physical depth to the surface of the water from the suspension point.
  - b. Cut a piece of stranded, stainless steel wire (Teflon coated is best) so that the logger will hang about 2 feet below the ground surface but always above the water surface.
2. Attach the wire to the suspension point and to the logger cap.
3. Relaunch the logger if desired (if a laptop or a HOBO U-Shuttle is available).
4. Lower the logger into the well or stilling well. Make sure the logger does not go below the water surface. See the diagram in the previous section.
5. Record the deployment time.

### Reading Out the Logger

To read out the logger for water level data (see later in this section for steps to read out a water level logger used for barometric pressure data):

1. Measure the water depth using the original reference point with the correct sign.
2. Record depth and date and time.
3. Pull the logger out of the well.
4. Remove the logger from its cap, leaving the suspension undisturbed. Check the communications window for any fouling and wipe it off if necessary. **Note:** There may be water in the end cap. This is normal; this water will not penetrate the waterproof seal around the communications window in the logger.
5. Read out the data using a laptop or shuttle.
6. Save the data in a test folder location.
7. Redeploy the logger (optional) as described later in this section.

To read out a U20L logger used for barometric pressure data:

1. Remove the logger from the well.
2. Read out the data using a laptop or shuttle.

3. Save the data in a test folder location.
4. Redeploy the logger (optional) as described below.

If you are redeploying the logger, you must first make sure that it is launched. If you used the HOBO Waterproof Shuttle to offload data, the shuttle automatically performs a synchronized relaunch of the logger so that data is logged on the same measurement intervals. If you wish to change the launch settings, you must launch the logger using HOBOWare Pro.

The existing suspension can be reused as long as the water level logger remained in the water and the barometric logger remained out of the water for the entire test interval. Take a new reference reading with the date and time as described in this section. Record this information in your field notebook to use later to calibrate the data, which will zero out any drift error.

### Processing Water Level Data using Barometric Pressure Data

To determine water level using barometric pressure data, use the Barometric Compensation Assistant in HOBOWare Pro as described below.

If you are using barometric pressure data from a HOBO weather station, you can use the data file as if it were U20L barometric data. For data from sources other than Onset products, see *Barometric Data from Other Sources* below.

1. In HOBOWare Pro, open the water depth data file. The Plot Setup window appears.
2. Uncheck all boxes except "Abs. Pressure."
3. Run the Barometric Compensation Assistant.
  - a. Select the assistant and click the Process button.
  - b. Select the water density box that best describes the water that you are measuring or enter the actual water density.
  - c. Check the Use a Reference Water Level box and enter the reference water level that you measured at the beginning of the deployment.

Enter the water level as a positive number if it is measured upward from a reference point below the water's surface, such as the water's height above sea level. This illustration shows an example of when to enter the water level as a positive number.

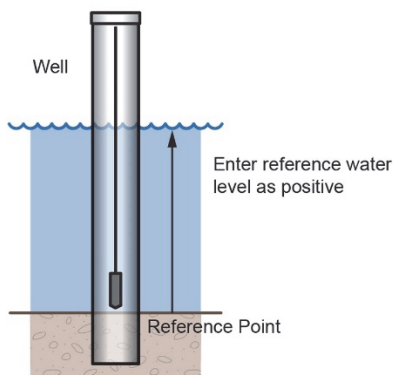

Enter the water level as a negative number if it is measured downward from a reference point above the water's surface, such as the top of the well. This illustration shows an example of when to enter the water level as a negative number.

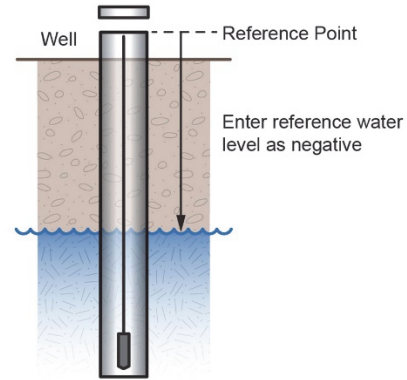

- d. Select the date and time from the pull-down menu that is closest to the recorded date/time for the measurement. If you measured the depth before deployment because of pipe size, then select a date/time after the start of the deployment.
  - e. Check "Use Barometric Data file."
  - f. Click the Choose button. This will allow you to select the data file to use for barometric pressure compensation.
  - g. Select and open the data file.
  - h. Click the Create New Series button. A new Plot Setup window appears.
4. Select the Water Level checkbox and any other series that you want plotted. Click the Plot button to obtain a plot of the resulting water level data.

Measurement error can be caused by manual measurement error, sensor drift, or change in the suspension cable length.

To quantify measurement error (which is ideally zero), compare the calculated water level at the end of the plot with the water level measured just before you removed the water level logger.

### Barometric Data from Other Sources

If you choose to use barometric pressure from a third-party weather station or barometric logger, you need to convert the date, time, and pressure data to a text file with special header requirements. For information on how to set up the text file, see the HOBOWare Help or User Guide. It is easiest to do this work in Microsoft® Excel® and then save it as a text file.

If you choose to use barometric pressure from an online weather station, such as the National Weather Service, the measured barometric pressure is modified to be at sea level. This sea level pressure is useable since all pressure offsets are zeroed when you enter the reference measurement.

When you select the barometric data file in the Barometric Pressure Assistant (see previous section), select the text file that you generated. Select tab or comma for the data format and data separation characters and then import the barometric data.

## Maintenance

The logger requires the following periodic maintenance to ensure optimal operation:

- **Protect the logger. This logger can be damaged by shock.** Always handle the logger with care. The logger may lose its calibrated accuracy or be damaged if it is dropped. Use proper packaging when transporting or shipping the logger.

**Important: Do not attempt to open the logger housing!** Unscrewing the nose cone of the logger will cause serious damage to the pressure sensor and logger electronics. There are no user serviceable parts inside the case. Contact Onset Technical Support if your logger requires servicing.

- **Periodically inspect the logger for biofouling.** Biological growth on the face of the pressure sensor will throw off the pressure sensor's accuracy. Organisms that grow inside the sensor nose cone and on the sensor itself can interfere with the sensor's operation and eventually make the sensor unusable. If the deployment area is prone to biofouling, check the logger periodically for marine growth.
- **Be careful of solvents.** Check a materials-compatibility chart against the wetted materials listed in the Specifications table before deploying the logger in locations where untested solvents are present. The logger has Viton and Buna-N O-rings, which are sensitive to polar solvents (acetone, ketone), ammonia, chlorine, and brake fluids. The sensor is housed in an acetal end cap. Acetal is resistant to most solvents, fuels, and lubricants. The black polypropylene cap is provided to help protect the communications window. The polypropylene communications window is sealed as an additional barrier to prevent water and dirt from entering the logger housing.

## Compensating for Drift

All pressure sensors drift over time. The drift for the pressure sensor and electronics in the HOBO U20L Water Level logger is less than 0.5% FS (worst case) per year. In most applications, drift is not a significant source of error, because the offset created by any drift is zeroed out when you take a manual reference level measurement and use the logger software to automatically calculate the level readings relative to the reference measurement. In effect, you are re-zeroing the sensor each time you apply a reference reading to the data file.

Pressure sensor drift matters only when absolute pressure values are needed, or if there are no recent reference level or depth measurements available. For example, if the logger is deployed for one year and no new reference level readings are taken during the deployment, it is possible that the sensor could have drifted as much as 0.5% FS by the end of the deployment.

It is possible to determine the actual amount of drift during a deployment if a reference level is taken at the beginning and the end of a long-term deployment. The results of applying the two different reference levels (once at the beginning of the data file, and again at the end of the data file) can be compared. Any difference between the files indicates the amount of sensor drift (assuming accurate reference levels).

## Verifying Accuracy

You can check the *differential accuracy* of your loggers for water level measurements by deploying the loggers at two depths and comparing the difference in level readings. When verifying the accuracy this way, be sure to allow the loggers' temperature to stabilize at each depth. Use the logger software to convert the readings from pressure to level. The level readings should be taken close enough together that the barometric pressure does not change.

You can check the *absolute pressure accuracy* of your HOBO U20L Water Level Logger by comparing its ambient pressure readings to a second HOBO logger. Their readings should be within each other's specified accuracy. Alternatively, you can check the pressure reading against an accurate local barometer. If you use a non-local source of barometric information, such as the NOAA website, adjust for altitude.

## Battery Guidelines

The battery in the HOBO U20L Water Level Logger is a 3.6 Volt lithium battery.

- **Battery Life.** The battery life of the logger should be about five years or more. Actual battery life is a function of the number of deployments, logging interval, and operation/storage temperature of the logger. Frequent deployments with logging intervals of less than one minute, and continuous storage/operation at temperatures above 35°C will result in significantly lower battery life. For example, continuous logging at a one-second logging interval will result in a battery life of approximately one month.

To obtain a five-year battery life, a logging interval of one minute or greater should be used and the logger should be operated and stored at temperatures between 0° and 25°C (32° and 77°F).

- **Battery Voltage.** The logger can report and log its battery voltage. If the battery falls below 3.1 V, the logger will record a "bad battery" event in the datafile. If the datafile contains "bad battery" events, or if logged battery voltage repeatedly falls below 3.3 V, the battery is failing and the logger should be returned to Onset for battery replacement.
- **Replace the Battery.** To have your logger's battery replaced, contact Onset or your place of purchase for return arrangements. Do not attempt to replace the battery yourself. Severe damage to the logger will result if the case is opened without special tools, and the warranty will be voided.

 **WARNING:** Do not cut open, incinerate, heat above 100°C (212°F), or recharge the lithium battery. The battery may explode if the logger is exposed to extreme heat or conditions that could damage or destroy the battery case. Do not dispose of the logger or battery in fire. Do not expose the contents of the battery to water. Dispose of the battery according to local regulations for lithium batteries.